

Instruments

1. A) Grande Cymbale Chinoise (Crash Cymbal) 7 1
 Grosse Caisse, très grave (Bass Drum, very deep) 2
 Cencerro (muffled) F) 1
 Tam-tam clair (high Tam-tam) 1
2. B) Gong 1
 Tam-tam clair (high Tam-tam) 1
 Tam-tam grave (low Tam-tam) 1
 Cencerro (muffled) F) 1
3. 2 Bongos (high and low) 2 2
 Caisse roulante (Side-drum) C) 2 (1) (bass drum)
 2 Grosse Caisses à plat, moyenne et grave (2 Bass Drums laid flat, medium and large size) 2 2
4. Tambour Militaire C) 3
 Caisse roulante (Side-drum) C) 2 (1)
5. Sirène claire (Siren, high) D) 6
 Tambour à corde (String-drum or Lion's Roar) 6
6. Sirène grave (Siren, low) D) 6
 Fouet (Slapstick) 4
 Güiro 5
7. 3 Blocs chinois, clair, moyen et grave (3 Wood Blocks, high, middle and low register) 4 4 4
 Claves 4
 Triangle 1
8. Caisse claire, détimbrée (Snare-drum, with snares relaxed) C) 2 (1)
 2 Maracas, claire et grave (2 Maracas, high and low) 5 5, 7
9. Tarole C) E) 3 (1)
 Caisse claire (Snare-drum) C) 3 (1)
 Cymbale suspendue (Suspended Cymbal) 1
10. Cymbales (Cymbals) (hand cymbals) 1
 Grelots (Sleigh Bells) 5
 Cloches (Tubular Chimes) 7

M985

MUSIC

V27 I66

- 11. Güiro 5
 Castagnettes (Castanets) 5
 Glockenspiel à clavier, with resonators 7
- 12. Tambour de Basque (Tambourine) 5
 2 Enclumes, la première plus aiguë (2 Anvils, the first higher) | |
 Grand Tam-tam (very deep) |
- 13. Fouet (Slapstick) 4
 Triangle 1
 Grelots (Sleigh Bells) 5
 Piano G) 7

- A) A mallet in each hand.
- B) A mallet in each hand; use very elastic strokes; even in the *ff*, the combined weight of arm and mallet are sufficient; do not kill the tone.
- C) Skin, felt, sponge or wooden sticks are to be used strictly as indicated.

R
 |
 X

The notation | indicates rim shot. *which kind*

D) Sirens: Sterling Type H (Part No. 73 PU. PB.) hand operated with thumb brake. If unobtainable, substitute with theremin instruments. Mouth sirens are to be strictly avoided.

E) Tarole: A flat military high pitched drum with snares.

F) Cencerro: A cow bell with handle and no clapper: it is struck with drum stick and muffled by inserting a piece of soft material in the bell.

G) The symbol  indicates all chromatic intervals between the

two notes and must be played simultaneously making use of the forearm. The chord is to be played without stiffness and without brutality.

music 402794

• IONISATION •

Chart for disposition of Percussion Ensemble suggested by Morris Goldenberg,
Instructor of Percussion, Juilliard School of Music.

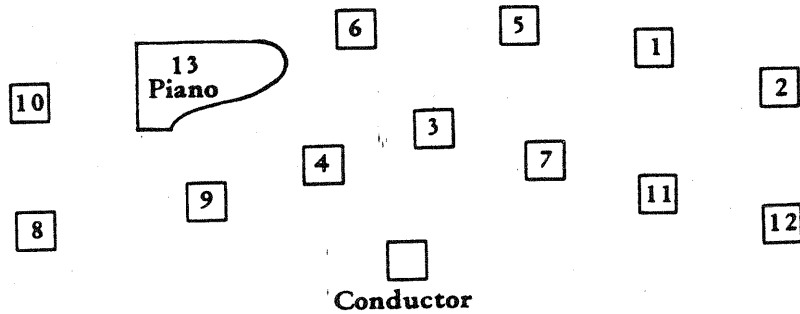

Charts for Individual Multiple Percussionists

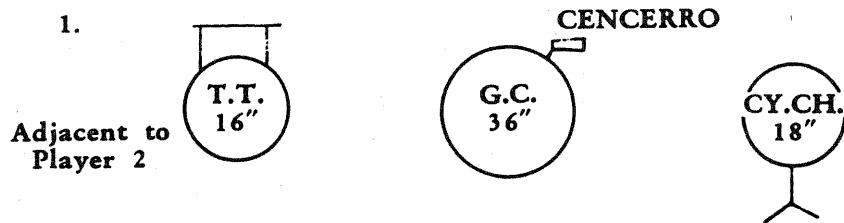

Footnote: Use soft Timpani mallet at outset. After ⑦ use Bell mallet in R.H. for Cowbell and Timpani mallet in L.H.



Footnote: See prototypes for Gong and Tam-Tam at end of section.

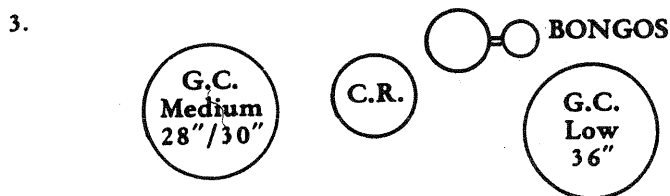

Footnote: Both Bass Drums are to be laid flat.



Footnote: The Caisse Roulante or Tenor Drum has no snares and is almost like a small Bass Drum. The Tambour Militaire, known also as either the Field or Parade Drum, has adjustable side snares.

5.

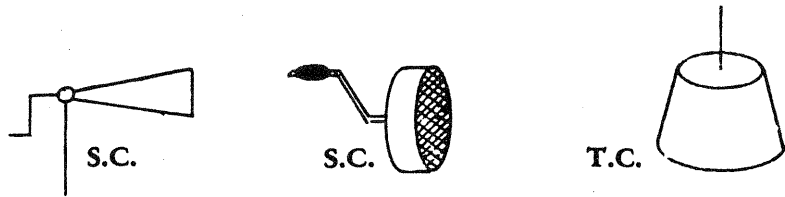

Footnote: See prototypes of High Siren and String Drum at end of Section.

6.

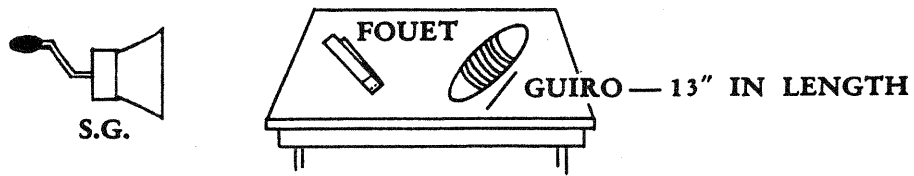

Footnote: See prototypes of Low Siren at end of section.

7.

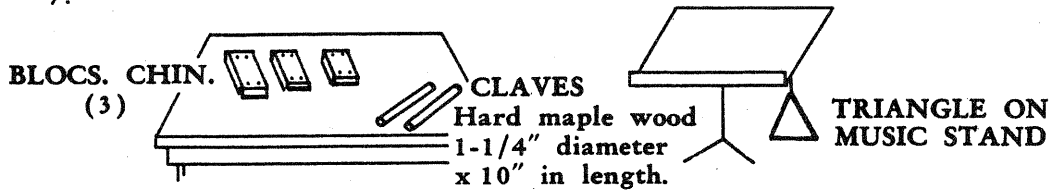

Footnote: Use Chinese Blocks (or the equivalent Wood Blocks) of 3 different pitches. Do *not* use Temple Blocks.

8.

NO DIAGRAM NECESSARY

9.

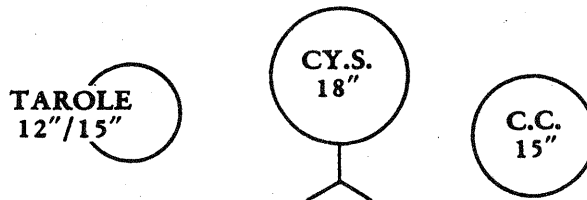

Footnote: The shell of the Tarole is extremely shallow.

10.

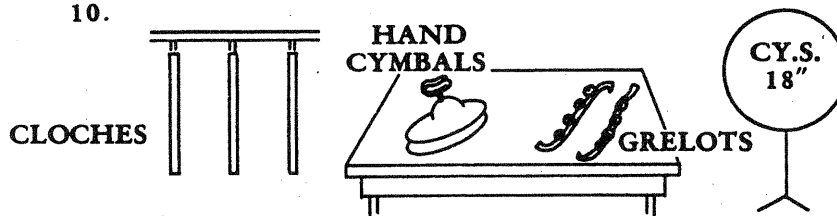

Footnote: Use Hand Cymbals wherever possible. The Suspended cymbal is only an alternative. (With wood sticks.)

11.

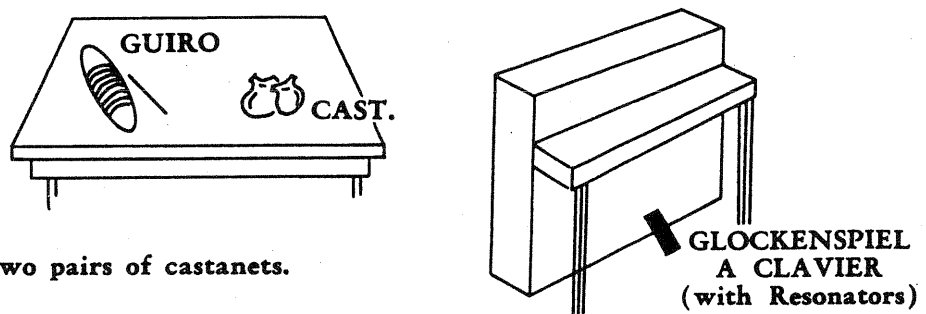

Footnote: Use two pairs of castanets.

12.

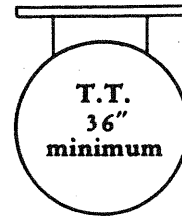
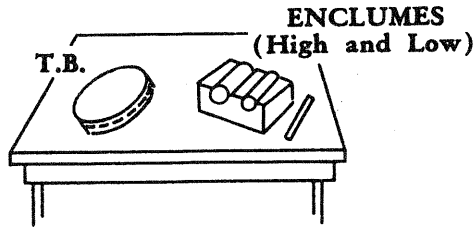

Footnote: See prototype of Anvils at end of page.

13.

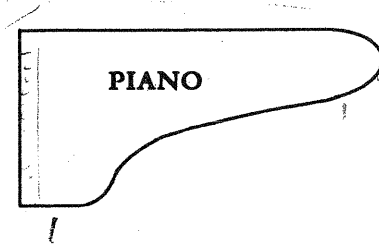
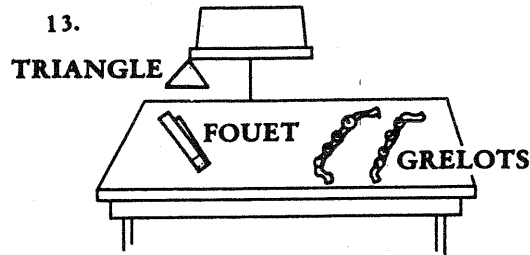

Prototypes

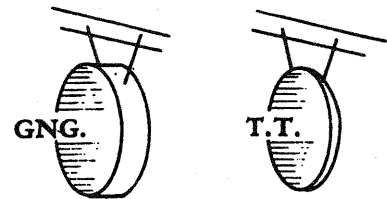
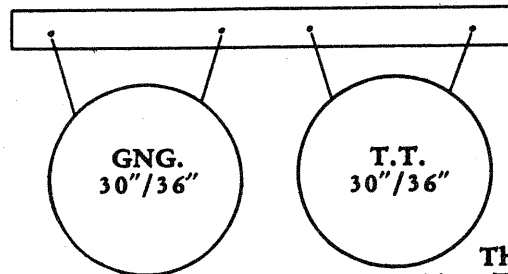

This is a profile view of the Gong and Tam-Tam to show their basic differences.

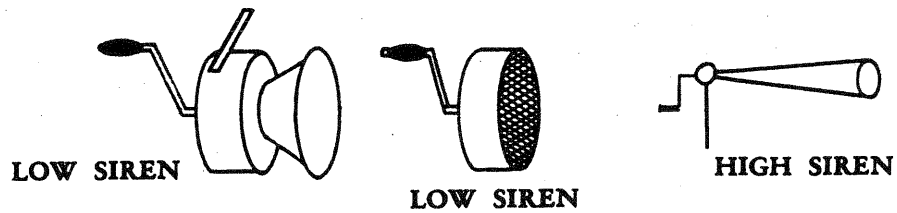

Footnote: With brake equipment.

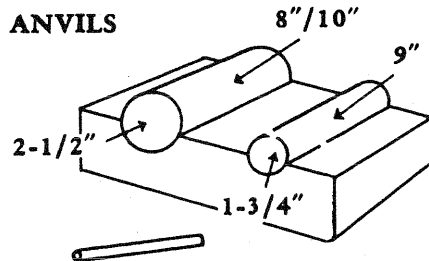

Footnote: Indentations in holder must be lined with soft felt to obtain maximum of resonance. To obtain resonance hit both tubes simultaneously with beater (small piece of tubing) held by the middle. Damping is obtained in the same fashion but keeping the contact with the two tubes.

STRING DRUM
(Lion's Roar)

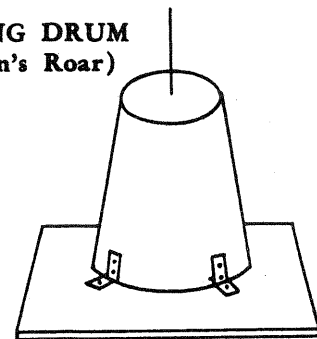

ANALYSIS

by Nicolas Slonimsky

Bars 1-8. Introduction. A characteristic figure is sounded by two Bass Drums (laid flat). The Sirens, one high, the other low, enter in rotation, starting from *ppp*, swelling to *mp*. The String-Drum enters in the seventh bar, starting a tremendous crescendo of the Metal Group (Gongs, Tam-tams, Cymbals, Triangle). The crescendo ends abruptly giving way to

The First Subject. Bars 9-12 1 (with an upbeat). The Tambour Militaire gives out the theme, accompanied by twin Bongos (the Bongos figure may be considered a Countersubject).

Bars 13-16 2 are bars 1-4 with slight modifications. Bar 17 equals bar 9.

Bars 18-20 3. Episode. The Tarole, alternating with the Chinese Blocks, gives out a figure partly derived from the Subject.

Bars 21-26 4 & 5. The first Subject is repeated for two bars, continuing in a new figure in Bar 23. The Bongos enter in strict imitation of the Subject, continuing in free counterpoint. The Tarole repeats its episodic figure.

Bar 27 (compound, 2/4 plus 3/8), after a Codetta played by the Chinese Blocks, leads to two 4/4 bars (28 and 29) with thematic figures of the Tambour Militaire. A syncopated Codetta in a 3/8 bar for Claves, leads to the return of 4/4 time (Bar 31). There is a Codetta for the Chinese Blocks in the following 5/4 bar, where the quintuple figure of the second Subject is anticipated.

Bars 33-42 6 & 7. *claves* 4/4 time. Free episodic development. A sudden outburst of sonority in Bar 38 is continued crescendo.

Bar 43 in 5/8. A Codetta for the Chinese Blocks leads to the second Subject.

Bars 44-50 8. Second Subject — a characteristic figure in quintuple sixteenth notes, syncopated, interrupted and doubled, is given out by five players simultaneously (Bongos, Tambour Militaire, Chinese Blocks, Maracas, Tarole). The time-signatures are successively, 3/4, 5/4, 3/4, 5/4, 3/4, 5/8, 4/4.

Bars 51-55 9 4/4. All-metal in *p*, *mf* and *f* in various instruments (Anvils, Cymbals, Gongs, Tam-tams, Triangle, accompanied by Sirens). Bars 56-65 10 & 11 introduce thematic bits in the entire orchestra, leading to an all-metal crash on a fermata in Bar 65.

Bar 66 12, in 5/4 — another outburst of sound; Bar 67, in 4/4, Pianissimo; Bar 68, in 5/4 repeats Bar 66 with some changes in orchestration.

Bars 69-72 in 4/4. The first Subject reappears in the Tambour Militaire. But instead of the original figure of Bar 9, the Bongos use for counterpoint the figure of the Tambour Militaire in Bar 23.

Bar 73, in 5/4, recalls the second Subject, in two figures of quintuple sixteenth notes. Bar 74, in 3/4, leads through a tremendous crescendo, to Coda. Bars 75-91 13

Bars 75-79. Time-signature 4/4. Instruments of definite pitch (Piano, Bells and Glockenspiel à Clavier) enter. The first Subject is re-stated by the Tambour Militaire. Bar 80, in 2/4, contains a Codetta for Chinese Blocks. Bars 81-82, in 3/4, have a solo for the Tarole. Bars 83-91 repeat thematic bits of the first Subject. The conclusion is in pianissimo, on a long fermata.

to Nicolas Slonimsky
IONISATION

(for Percussion Ensemble of 13 Players)

Edgard Varèse

$\text{♩} = 69$

1. Grande Cymbale Chinoise

2. Grosse Caisse (très grave)

3. Gong
Tam-tam clair
Tam-tam grave

4. 2 Bongos $\left\{ \begin{array}{l} \text{clair} \\ \text{grave} \end{array} \right.$
Caisse roulante

5. 2 Grosse Caisse $\left\{ \begin{array}{l} \text{moyenne} \\ \text{grave} \end{array} \right.$

6. Tambour militaire
Caisse roulante

7. Sirène claire
Tambour à corde

8. Sirène grave
Fouet
Güiro

9. 3 Blocs Chinois $\left\{ \begin{array}{l} \text{clair} \\ \text{moyen} \\ \text{grave} \end{array} \right.$
Claves
Triangle

10. Caisse claire (détimbrée)
2 Maracas $\left\{ \begin{array}{l} \text{Clair} \\ \text{Grave} \end{array} \right.$

11. Tarule
Caisse claire
Cymbale suspendue

12. Grelots
Cymbales

13. Güiro
Castagnettes

14. Tambour de Basque
Enclumes

15. Piano

Baguettes Timbales (en peau)

ppp, *p*, *mp*, *f*

3, *5*, *6*

pouce

I

1. Grande Cymbale Chinoise
Grosse Caisse (très grave)

2. Gong
Tam-tam clair
Tam-tam grave

3. 2 Bongos... clair
grave
Caisse Roulante
2 Grosse Caisse moyenne
grave

4. Tambour militaire
Caisse roulante

5. Sirène claire
Tambour à corde

6. Sirène grave
Fouet
Güiro

7. 3 Blocs Chinois clair
moyen
grave
Claves
Triangle

8. Caisse claire
2 Maracas... Claire
Grave

9. Tarole
Caisse claire
Cymbale suspendue

10. Grelots
Cymbales

11. Güiro
Castagnettes

12. Tambour de Basque
Enclumes...

13. Piano